

QUICK REFERENCE

This Quick Reference contains supply loading information and general care and maintenance procedures for the Monarch® Pathfinder® Ultra® *Platinum* 6039™ printer. For more detailed information, refer to the *Operator's Handbook* available on our Web site (www.paxar.com).

Information in this document supercedes information in previous versions. Check our Web site for the latest documentation and release information.

Getting Started

1. Review the printer safety information in the *Regulatory Compliance* document provided with your printer.
2. Charge the main battery. Use either the Monarch® 9462™ or 9465™ battery charger. Refer to the documentation with those chargers for more information.

Important: You must charge the main battery when you receive the printer, even if you do not use it right away. Refer to the *Operator's Handbook* for important battery safety information.

3. Insert the main battery into the printer.
4. Attach the safety strap found in the documentation package.
5. Load supplies in the printer.
6. Turn on the printer and wait 30 seconds for the desktop to load.

Your System Administrator must have already loaded an application in the printer before you can use it.

Monarch®, Pathfinder® Ultra®, 6039, 9462, and 9465 are trademarks of Paxar Americas, Inc.
Paxar® is a trademark of Paxar Corporation.
Avery Dennison® is a trademark of Avery Dennison Corporation.



Attaching the Safety Strap

1. Turn the printer upside down, resting its top in the table.
2. Remove the stylus strap from the loop.

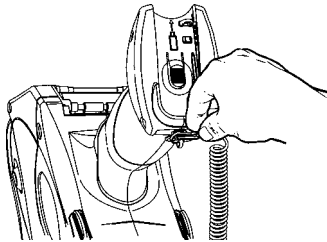

3. Take the thin end of the safety strap, and push it through the loop at the bottom of the printer handle (near the battery compartment).

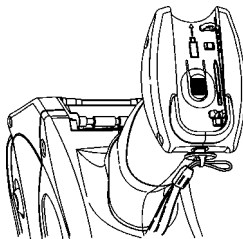

4. Push the thick end of the safety strap through the thin end's loop.

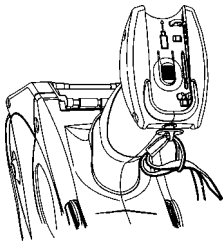

5. Pull the strap. It may be necessary to help the thin end's loop fit over the plastic piece in the middle of the strap. Pull the strap tight.
6. Attach the stylus strap to the loop as shown.

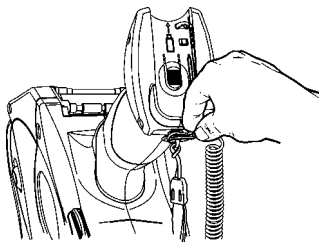

Changing the Main Battery

Always take the main battery out of the printer when storing the printer and connect the Battery Backup Power.

1. Turn the printer over and press the button on the battery compartment door (at the bottom of the printer's handle) and slide it open.

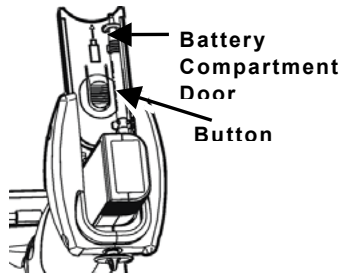

2. Turn the printer upright, holding your palm beneath the open battery compartment. Hit the printer on your hand and catch the battery as it slides out.

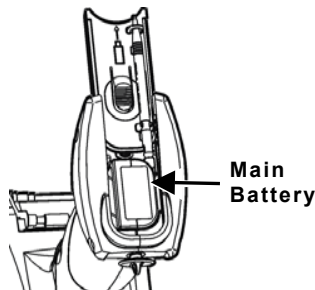

3. Insert a new battery into the compartment (connector end first).
4. Slide the compartment door shut until it clicks into place.

Charging the Backup Battery

The internal backup battery is a 3.6-volt lithium-ion battery that maintains the printer's system settings. The backup battery maintains its charge through the main battery or the Battery Backup Power. When fully charged, the backup battery provides seven days of power. To keep the battery fully charged, connect the Backup Battery Power whenever you remove the main battery.

Note: If the printer does not have a main battery or is not connected to the Battery Backup Power, it loses its charge and the printer's system settings.

5. Remove the main battery from the battery compartment.
6. Connect the Battery Backup Power as shown.

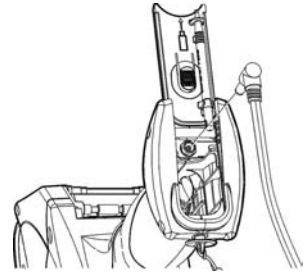

Loading Supplies

1. Turn on the printer.
2. Press the latch buttons and open the supply cover.

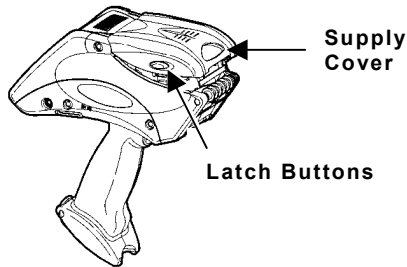

3. Pull back the supply lock tab.

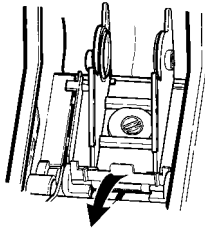

4. Open the spring-loaded supply holder. Spread the supply holder tabs apart with one hand so it adjusts to the size of your supply roll. You can set it at 1.2", 1.5", and 2.0".

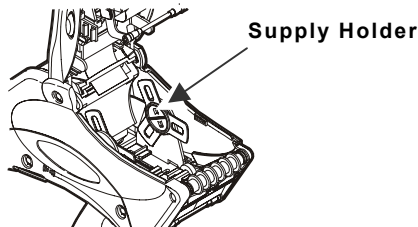

5. Press the supply lock tab down to lock the supply holder in place.

6. Place a roll of supply in the supply holder so it unrolls from the bottom.

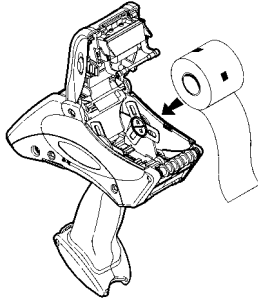

7. Load the supplies for the printing mode you want: Peel or Non-Peel.

Loading for Non-Peel Mode

1. Feed the supply **under** the applicator roller and **over** the label deflector.

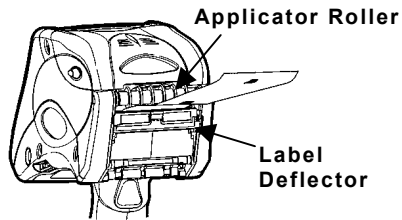

2. Close the supply cover.
3. Select **Load Supply** from the printer icon menu, choose your supply type, and then select **Calibrate**.

Loading for Peel Mode

1. Peel and discard the first four inches of labels from the backing paper.
2. Hold the printer upright and gently press down on the label deflector. It may be stiff.

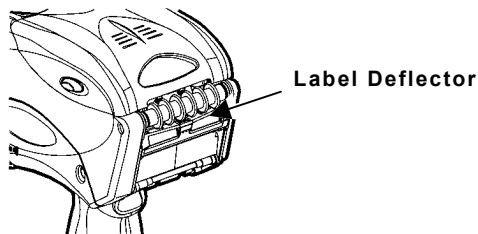

3. Feed all four inches of the backing paper **over** the peel bar and **under** the applicator roller and the label deflector.

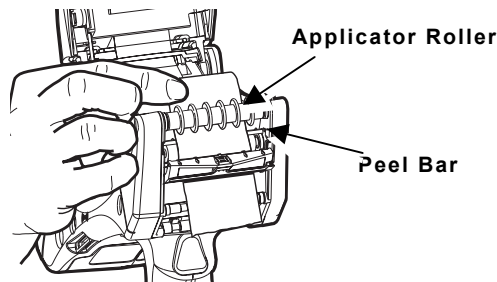

4. Push the label deflector up until it snaps into place.
5. **Partially** close the cover to the first position.
6. Pull the backing paper **over** the guide roller, down to the pinch and feed rollers.

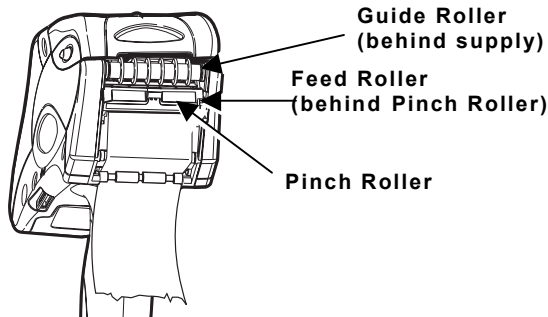

7. Hold the backing paper edge between the feed and pinch rollers and press the trigger.
8. Close the cover completely.
9. Select **Load Supply** from the printer icon menu, choose your supply type, and then select **Calibrate**.

Removing Supplies in Peel Mode

- ◆ Tear the backing paper just above the pinch roller.
- ◆ Open the supply cover completely.
- ◆ Spread the supply holder tabs apart and remove the supply roll.
- ◆ Carefully pull out the supply backing paper still in place between the pinch and feed rollers.

Changing the Display Settings

To change the backlight, sound (beep) and other standard Windows options, from the Start Menu select **Settings, Control Panel**.

Using the Keypad

The printer's keypad appears below.

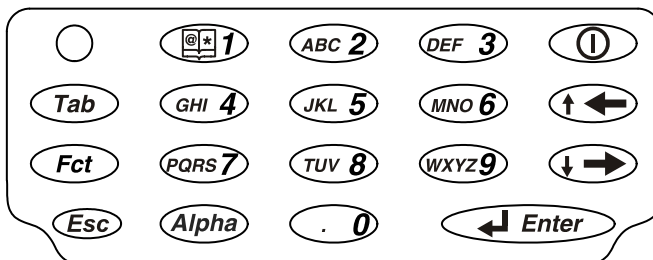

Key(s)	Description
Enter	Accepts data or a menu selection.
Tab	Tabs to the next tab stop or the next field. Pressing Fct + Tab backspaces a tab stop or returns to the previous field.
Fct	Performs an application-defined function when pressed with a single-digit number.
Esc	Exits the current screen or application.
Alpha	Enters upper case or lower-case alphabetic mode.
Right Arrow	Moves the cursor to the right in a menu. Pressing Fct + right arrow scrolls the cursor down in a menu.
Left Arrow	Moves the cursor to the left in a menu. Pressing Fct + left arrow scrolls the cursor up in a menu. Backspaces in Alpha mode.
On/Off (power icon)	Turns the printer on and off.
Numeric/ Alphabetic	Displays a numeric digit or letter. See “Entering Special Characters/Symbols” for more information.

Entering Data

Entering data using the keypad is similar to entering data on a cell phone. There are three data entry modes:

- ◆ **Normal (Numeric) mode – Default.** Press the key to display what appears on the face of the key (numbers).
- ◆ **Lower-Case Alphabetic mode –** Press **Alpha** once to display lower-case letters. Press the key several times until you see the letter you need. For example, to select lower-case c, press **Alpha** once and **2** three times.
- ◆ **Upper-Case Alphabetic mode –** Press **Alpha** twice to display upper-letters. Press the key several times until you see the letter you need. For example, to select upper-case C, press **Alpha** twice and **2** three times.

Entering Special Characters/Symbols

The table shows how to enter special characters and symbols when in Lower-case and Upper-case Alpha Mode.

Press Key	Lower-case Alpha Mode Press Alpha Once	Upper-case Alpha Mode Press Alpha Twice
1	<space> : < (‘	<space> ; >) “
0	. - + / *	. = @ % \$

Cleaning the Printer

Do not use sharp objects to clean the printer. **Do not** use household cleaners to clean the printer. Use isopropyl alcohol on the interior areas only (except where specified), never on the exterior.

Cleaning the Printhead

1. Turn off the printer.
2. Open the supply cover and remove the supplies.
3. Check the supply holder for adhesive buildup and clean it if necessary.
4. Ground yourself by touching a metal object other than the printer. Grounding prevents electrostatic discharge, which may damage the printer.
5. Clean the printhead area of all adhesive and label particles using a Monarch Cleaning Pen (#114226) or a soft cloth moistened with isopropyl alcohol. Allow the printer to dry before reloading supplies.

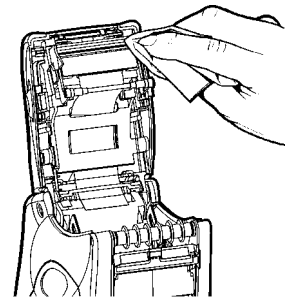

Cleaning the Pinch and Feed Rollers

1. Turn off the printer and open the supply cover.
2. Remove the supplies.
3. Turn the platen roller with your fingers and run a dry, lint-free cloth across the pinch and feed rollers as they turn. Make sure the rollers are clean all the way around. If that does not work, use a cloth dampened slightly with distilled water.
4. Clean any adhesive buildup you see as the rollers turn.
5. Reload the supplies after the printer dries.

Cleaning the Black Mark Sensor

1. Turn off the printer and open the supply cover.
2. Remove the supplies
3. Clean the black mark sensor with a dry cotton swab.
4. Reload the supplies and close the supply cover.

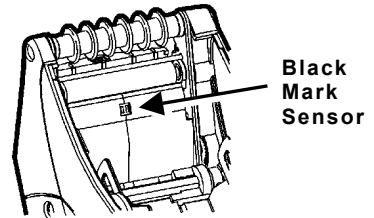

Cleaning the On-Demand Sensor

1. Turn off the printer and open the supply cover.
2. Remove the supplies.
3. Open the label deflector.
4. Clean the on-demand sensor with a soft cloth moistened with distilled water.
5. Reload the supplies and close the label deflector and supply cover.

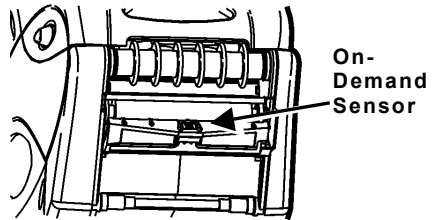

Cleaning the Platen Roller

Clean the platen roller when you see significant adhesive build-up or when a label is wrapped around the platen roller.

1. Turn off the printer and open the supply cover.
2. Remove the supplies. See "Removing Supplies" in Chapter 3 for more information.
3. Hold the printer upright and gently press down on the label deflector. It may be stiff.

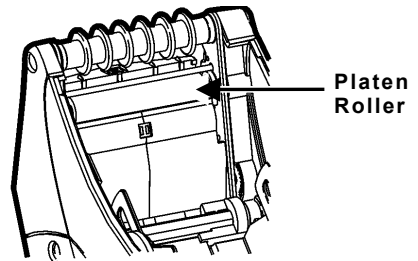

4. Use a dry, soft-bristle brush, such as a toothbrush, to clean the platen roller.
5. Turn the platen roller with your finger and then continue cleaning.
6. Reload the supplies, close the label deflector and supply cover.

If the brush does not remove all the adhesive, moisten a cotton swab with isopropyl alcohol and run the cotton swab across the platen roller. Turn the platen roller with your finger to make sure it is clean all the way around. After cleaning, feed several inches of supply through without printing to remove any remaining isopropyl alcohol.

Cleaning the Scanner Flex Cable

Occasionally, adhesive buildup appears on the scanner flex cable, as shown below. To clean the cable:

1. Turn off the printer and open the supply cover.
2. Inspect the scanner flex cable. At any place that adhesive buildup appears, clean the cable with 99% isopropyl alcohol and a cotton swab.
3. Close the supply cover.

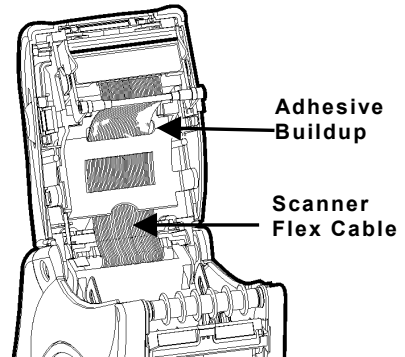

Cleaning the Scanner Window and Display Screen

1. Moisten a soft cloth with distilled water.
2. Wipe the window and the display screen until they are clean.

Clearing Supply Jams

1. Turn off the printer.
2. Open the supply cover completely.
3. Open the label deflector.
4. Remove the supplies.
5. Carefully remove any jammed supply and close the deflector.
Do not pull the jammed supply out through the front of the label deflector.
Do not use sharp objects to remove jammed supplies.
6. Remove the extra supply between the pinch and feed rollers and clean any adhesive buildup.
7. Reload the supplies and close the label deflector.

Troubleshooting

This section lists some common problems and their solutions.

Problem	Solution
Printer does not print.	Switch to a fully-charged battery. Load the supply correctly. Clean the printhead.
Printer does not feed.	Switch to a fully-charged battery. Close the supply cover completely. Load the supply correctly. Check the platen roller for jammed labels.
Print has voids or is too light.	Load the supply correctly / Check for damage. Close the supply cover completely. Switch to a fully-charged battery. Clean the printhead.
Printer partially prints and fails to respond to the keypad or trigger.	Re-load the supply or load new supplies. Clear any supply jams. Clean the printhead. Switch to a fully-charged battery.
Scanner will not scan a bar code.	Alter the scan angle and distance. Clean the scanner window or move to a more dimly lit area. Scan a bar code you have previously scanned correctly. Check bar code for voids. Run a scan test.
Display does not turn on.	Switch batteries/Make sure power is on.
Printer and display locks up.	Push your stylus into the tiny hole under the left side of keypad and soft reset the printer.

Error Codes

Following are some common error codes you may receive. See your System Administrator if you receive any codes not listed here.

Code(s)	Description
004 – 005	Supply size is incorrect. Reload the correct supplies.
267 – 271 410 – 413	Communication error. See your System Administrator.
703 – 704	Load supplies or make sure they are loaded correctly.
750	Printhead is overheated. Turn off the printer to let it cool.
751 – 753	Check the supplies to see if they are loaded correctly.
756	The printer is out of supplies. Load supplies.
757	The calibrated supply length differs by plus or minus .25 inches from the format. Load supplies.
758	Check supply. Either the supply is not seen, or the on-demand sensor is broken (purchase optional). Check for a label jam. Clear the supply path or reload supplies. The printer does not recalibrate after this error.
762	Low battery. Recharge the battery.
763	Waiting to dispense label. Press Enter.
768	Printhead error. See your System Administrator.
790 – 791	Turn off the printer. Wait two seconds and turn it back on.
904 – 911	System error. See your System Administrator.
SYSTEM ERROR VECTOR ##	System error. See your System Administrator.

